

FEATURES

- Requires no external components
- Supply voltage range covers from 2.7V to 5.5V
- Measures temperatures from -55°C to +125°C in 0.5°C increments; Fahrenheit equivalent is -67°F to +257°F in 0.9°F increments
- Temperature is read as a 9-bit value
- Converts temperature to digital word in 750 ms (max)
- Thermostatic settings are user-definable and nonvolatile
- Data is read from/written via a 3-wire serial interface (CLK, DQ, $\overline{\text{RST}}$)
- Applications include thermostatic controls, industrial systems, consumer products, thermometers, or any thermally sensitive system
- 8-pin DIP or SOIC (208-mil) packages

PIN ASSIGNMENT

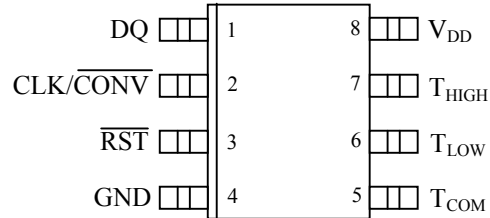

DS1620S 8-Pin SOIC (208-mil)

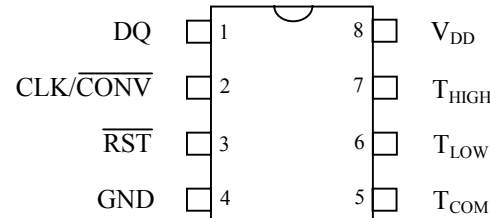

DS1620 8-Pin DIP (300-mil)

PIN DESCRIPTION

- DQ - 3-Wire Input/Output
- CLK/ $\overline{\text{CONV}}$ - 3-Wire Clock Input and Stand-alone Convert Input
- $\overline{\text{RST}}$ - 3-Wire Reset Input
- GND - Ground
- T_{HIGH} - High Temperature Trigger
- T_{LOW} - Low Temperature Trigger
- T_{COM} - High/Low Combination Trigger
- V_{DD} - Power Supply Voltage (3V - 5V)

DESCRIPTION

The DS1620 Digital Thermometer and Thermostat provides 9-bit temperature readings which indicate the temperature of the device. With three thermal alarm outputs, the DS1620 can also act as a thermostat. T_{HIGH} is driven high if the DS1620's temperature is greater than or equal to a user-defined temperature TH. T_{LOW} is driven high if the DS1620's temperature is less than or equal to a user-defined temperature TL. T_{COM} is driven high when the temperature exceeds TH and stays high until the temperature falls below that of TL.

User-defined temperature settings are stored in nonvolatile memory, so parts can be programmed prior to insertion in a system, as well as used in standalone applications without a CPU. Temperature settings and temperature readings are all communicated to/from the DS1620 over a simple 3-wire interface.

ORDERING INFORMATION

PART	PACKAGE MARKING	DESCRIPTION
DS1620	DS1620	8-Pin DIP (300 mil)
DS1620+	DS1620 (See Note)	Lead-Free 8-Pin DIP (300 mil)
DS1620S	DS1620	8-Pin SOIC (208 mil)
DS1620S+	DS1620 (See Note)	Lead-Free 8-Pin SOIC (208 mil)
DS1620S/T&R	DS1620	8-Pin SOIC (208 mil), 2000-Piece Tape-and-Reel
DS1620S+T&R	DS1620 (See Note)	Lead-Free 8-Pin SOIC (208 mil), 2000-Piece Tape-and-Reel

Note: A “+” symbol will also be marked on the package near the Pin 1 indicator

DETAILED PIN DESCRIPTION Table 1

PIN	SYMBOL	DESCRIPTION
1	DQ	Data Input/Output pin for 3-wire communication port.
2	CLK/ $\overline{\text{CONV}}$	Clock input pin for 3-wire communication port. When the DS1620 is used in a stand-alone application with no 3-wire port, this pin can be used as a convert pin. Temperature conversion will begin on the falling edge of $\overline{\text{CONV}}$.
3	$\overline{\text{RST}}$	Reset input pin for 3-wire communication port.
4	GND	Ground pin.
5	T _{COM}	High/Low Combination Trigger. Goes high when temperature exceeds TH; will reset to low when temperature falls below TL.
6	T _{LOW}	Low Temperature Trigger. Goes high when temperature falls below TL.
7	T _{HIGH}	High Temperature Trigger. Goes high when temperature exceeds TH.
8	V _{DD}	Supply Voltage. 2.7V – 5.5V input power pin.

Table 2. DS1620 REGISTER SUMMARY

REGISTER NAME (USER ACCESS)	SIZE	MEMORY TYPE	REGISTER CONTENTS AND POWER-UP/POR STATE
Temperature (Read Only)	9 Bits	SRAM	Measured Temperature (Two's Complement) Power-Up/POR State: -60°C (1 1000 1000)
T _H (Read/Write)	9 Bits	EEPROM	Upper Alarm Trip Point (Two's Complement) Power-Up/POR State: User-Defined. Initial State from Factory: +15°C (0 0001 1110)
T _L (Read/Write)	9 Bits	EEPROM	Lower Alarm Trip Point (Two's Complement) Power-Up/POR State: User-Defined. Initial State from Factory: +10°C (0 0001 0100)

OPERATION-MEASURING TEMPERATURE

A block diagram of the DS1620 is shown in Figure 1.

DS1620 FUNCTIONAL BLOCK DIAGRAM Figure 1

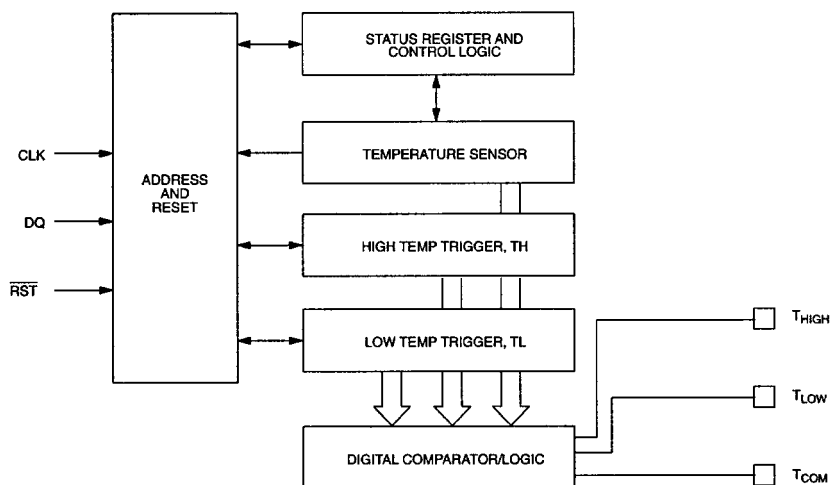

The DS1620 measures temperature using a bandgap-based temperature sensor. The temperature reading is provided in a 9-bit, two's complement reading by issuing a READ TEMPERATURE command. The data is transmitted serially through the 3-wire serial interface, LSB first. The DS1620 can measure temperature over the range of -55°C to $+125^{\circ}\text{C}$ in 0.5°C increments. For Fahrenheit usage, a lookup table or conversion factor must be used.

Since data is transmitted over the 3-wire bus LSB first, temperature data can be written to/read from the DS1620 as either a 9-bit word (taking $\overline{\text{RST}}$ low after the 9th (MSB) bit), or as two transfers of 8-bit words, with the most significant 7 bits being ignored or set to 0, as illustrated in Table 3. After the MSB, the DS1620 will output 0s.

Note that temperature is represented in the DS1620 in terms of a $\frac{1}{2}^{\circ}\text{C}$ LSB, yielding the 9-bit format shown in Figure 2.

TEMPERATURE, TH, and TL REGISTER FORMAT Figure 2

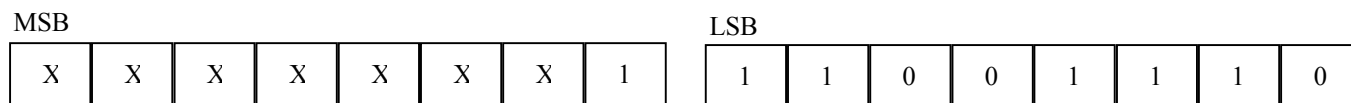

T = -25°C

Table 3 describes the exact relationship of output data to measured temperature.

TEMPERATURE/DATA RELATIONSHIPS Table 3

TEMP	DIGITAL OUTPUT (Binary)	DIGITAL OUTPUT (Hex)
+125°C	0 11111010	00FA
+25°C	0 00110010	0032h
+½°C	0 00000001	0001h
+0°C	0 00000000	0000h
-½°C	1 11111111	01FFh
-25°C	1 11001110	01CEh
-55°C	1 10010010	0192h

Higher resolutions may be obtained by reading the temperature, and truncating the 0.5°C bit (the LSB) from the read value. This value is TEMP_READ. The value left in the counter may then be read by issuing a READ COUNTER command. This value is the count remaining (COUNT_REMAIN) after the gate period has ceased. By loading the value of the slope accumulator into the count register (using the READ SLOPE command), this value may then be read, yielding the number of counts per degree C (COUNT_PER_C) at that temperature. The actual temperature may be then be calculated by the user using the following:

$$\text{TEMPERATURE} = \text{TEMP_READ} - 0.25 + \frac{(\text{COUNT_PER_C} - \text{COUNT_REMAIN})}{\text{COUNT_PER_C}}$$

OPERATION—THERMOSTAT CONTROLS

Three thermally triggered outputs, T_{HIGH}, T_{LOW}, and T_{COM}, are provided to allow the DS1620 to be used as a thermostat, as shown in Figure 3. When the DS1620's temperature meets or exceeds the value stored in the high temperature trip register, the output T_{HIGH} becomes active (high) and remains active until the DS1620's measured temperature becomes less than the stored value in the high temperature register, TH. The T_{HIGH} output can be used to indicate that a high temperature tolerance boundary has been met or exceeded, or it can be used as part of a closed loop system to activate a cooling system and deactivate it when the system temperature returns to tolerance.

The T_{LOW} output functions similarly to the T_{HIGH} output. When the DS1620's measured temperature equals or falls below the value stored in the low temperature register, the T_{LOW} output becomes active. T_{LOW} remains active until the DS1620's temperature becomes greater than the value stored in the low temperature register, TL. The T_{LOW} output can be used to indicate that a low temperature tolerance boundary has been met or exceeded, or as part of a closed loop system it can be used to activate a heating system and deactivate it when the system temperature returns to tolerance.

The T_{COM} output goes high when the measured temperature meets or exceeds TH, and will stay high until the temperature equals or falls below TL. In this way, any amount of hysteresis can be obtained.

THERMOSTAT OUTPUT OPERATION Figure 3

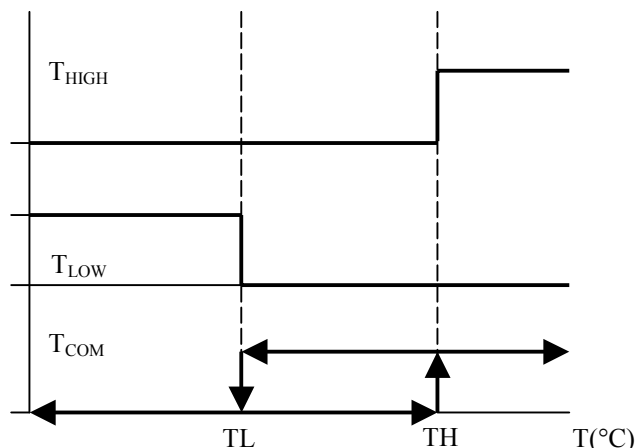

OPERATION AND CONTROL

The DS1620 must have temperature settings resident in the TH and TL registers for thermostatic operation. A configuration/status register also determines the method of operation that the DS1620 will use in a particular application and indicates the status of the temperature conversion operation. The configuration register is defined as follows:

CONFIGURATION/STATUS REGISTER

DONE	THF	TLF	NVB	1	0	CPU	1SHOT
------	-----	-----	-----	---	---	-----	-------

where

DONE = Conversion Done Bit. 1=conversion complete, 0=conversion in progress. The power-up/POR state is a 1.

THF = Temperature High Flag. This bit will be set to 1 when the temperature is greater than or equal to the value of TH. It will remain 1 until reset by writing 0 into this location or by removing power from the device. This feature provides a method of determining if the DS1620 has ever been subjected to temperatures above TH while power has been applied. The power-up/POR state is a 0.

TLF = Temperature Low Flag. This bit will be set to 1 when the temperature is less than or equal to the value of TL. It will remain 1 until reset by writing 0 into this location or by removing power from the device. This feature provides a method of determining if the DS1620 has ever been subjected to temperatures below TL while power has been applied. The power-up/POR state is a 0.

NVB = Nonvolatile Memory Busy Flag. 1=write to an E² memory cell in progress. 0=nonvolatile memory is not busy. A copy to E² may take up to 10 ms. The power-up/POR state is a 0.

CPU = CPU Use Bit. If CPU=0, the CLK/ $\overline{\text{CONV}}$ pin acts as a conversion start control, when $\overline{\text{RST}}$ is low. If CPU is 1, the DS1620 will be used with a CPU communicating to it over the 3-wire port, and the operation of the CLK/ $\overline{\text{CONV}}$ pin is as a normal clock in concert with DQ and $\overline{\text{RST}}$. This bit is stored in nonvolatile E² memory, capable of at least 50,000 writes. The DS1620 is shipped with CPU=0.

1SHOT = One-Shot Mode. If 1SHOT is 1, the DS1620 will perform one temperature conversion upon reception of the Start Convert T protocol. If 1SHOT is 0, the DS1620 will continuously perform temperature conversion. This bit is stored in nonvolatile E² memory, capable of at least 50,000 writes. The DS1620 is shipped with 1SHOT=0.

For typical thermostat operation, the DS1620 will operate in continuous mode. However, for applications where only one reading is needed at certain times or to conserve power, the one-shot mode may be used. Note that the thermostat outputs (T_{HIGH}, T_{LOW}, T_{COM}) will remain in the state they were in after the last valid temperature conversion cycle when operating in one-shot mode.

OPERATION IN STAND-ALONE MODE

In applications where the DS1620 is used as a simple thermostat, no CPU is required. Since the temperature limits are nonvolatile, the DS1620 can be programmed prior to insertion in the system. In order to facilitate operation without a CPU, the CLK/ $\overline{\text{CONV}}$ pin (pin 2) can be used to initiate conversions. Note that the CPU bit must be set to 0 in the configuration register to use this mode of operation. Whether CPU=0 or 1, the 3-wire port is active. Setting CPU=1 disables the stand-alone mode.

To use the CLK/ $\overline{\text{CONV}}$ pin to initiate conversions, $\overline{\text{RST}}$ must be low and CLK/ $\overline{\text{CONV}}$ must be high. If CLK/ $\overline{\text{CONV}}$ is driven low and then brought high in less than 10 ms, one temperature conversion will be performed and then the DS1620 will return to an idle state. If CLK/ $\overline{\text{CONV}}$ is driven low and remains low, continuous conversions will take place until CLK/ $\overline{\text{CONV}}$ is brought high again. With the CPU bit set to 0, the CLK/ $\overline{\text{CONV}}$ will override the 1SHOT bit if it is equal to 1. This means that even if the part is set for one-shot mode, driving CLK/ $\overline{\text{CONV}}$ low will initiate conversions.

3-WIRE COMMUNICATIONS

The 3-wire bus is comprised of three signals. These are the $\overline{\text{RST}}$ (reset) signal, the CLK (clock) signal, and the DQ (data) signal. All data transfers are initiated by driving the $\overline{\text{RST}}$ input high. Driving the $\overline{\text{RST}}$ input low terminates communication. (See Figures 4 and 5.) A clock cycle is a sequence of a falling edge followed by a rising edge. For data inputs, the data must be valid during the rising edge of a clock cycle. Data bits are output on the falling edge of the clock and remain valid through the rising edge.

When reading data from the DS1620, the DQ pin goes to a high-impedance state while the clock is high. Taking $\overline{\text{RST}}$ low will terminate any communication and cause the DQ pin to go to a high-impedance state.

Data over the 3-wire interface is communicated LSB first. The command set for the 3-wire interface as shown in Table 4 is as follows.

Read Temperature [AAh]

This command reads the contents of the register which contains the last temperature conversion result. The next nine clock cycles will output the contents of this register.

Write TH [01h]

This command writes to the TH (HIGH TEMPERATURE) register. After issuing this command the next nine clock cycles clock in the 9-bit temperature limit which will set the threshold for operation of the T_{HIGH} output.

Write TL [02h]

This command writes to the TL (LOW TEMPERATURE) register. After issuing this command the next nine clock cycles clock in the 9-bit temperature limit which will set the threshold for operation of the T_{LOW} output.

Read TH [A1h]

This command reads the value of the TH (HIGH TEMPERATURE) register. After issuing this command the next nine clock cycles clock out the 9-bit temperature limit which sets the threshold for operation of the T_{HIGH} output.

Read TL [A2h]

This command reads the value of the TL (LOW TEMPERATURE) register. After issuing this command the next nine clock cycles clock out the 9-bit temperature limit which sets the threshold for operation of the T_{LOW} output.

Read Counter [A0h]

This command reads the value of the counter byte. The next nine clock cycles will output the contents of this register.

Read Slope [A9h]

This command reads the value of the slope counter byte from the DS1620. The next nine clock cycles will output the contents of this register.

Start Convert T [EEh]

This command begins a temperature conversion. No further data is required. In one-shot mode the temperature conversion will be performed and then the DS1620 will remain idle. In continuous mode this command will initiate continuous conversions.

Stop Convert T [22h]

This command stops temperature conversion. No further data is required. This command may be used to halt a DS1620 in continuous conversion mode. After issuing this command the current temperature measurement will be completed and then the DS1620 will remain idle until a Start Convert T is issued to resume continuous operation.

Write Config [0Ch]

This command writes to the configuration register. After issuing this command the next eight clock cycles clock in the value of the configuration register.

Read Config [ACh]

This command reads the value in the configuration register. After issuing this command the next eight clock cycles output the value of the configuration register.

DS1620 COMMAND SET Table 4

INSTRUCTION	DESCRIPTION	PROTOCOL	3-WIRE BUS DATA AFTER ISSUING PROTOCOL	NOTES
TEMPERATURE CONVERSION COMMANDS				
Read Temperature	Reads last converted temperature value from temperature register.	AAh	<read data>	
Read Counter	Reads value of count remaining from counter.	A0h	<read data>	
Read Slope	Reads value of the slope accumulator.	A9h	<read data>	
Start Convert T	Initiates temperature conversion.	EEh	Idle	1
Stop Convert T	Halts temperature conversion.	22h	Idle	1
THERMOSTAT COMMANDS				
Write TH	Writes high temperature limit value into TH register.	01h	<write data>	2
Write TL	Writes low temperature limit value into TL register.	02h	<write data>	2
Read TH	Reads stored value of high temperature limit from TH register.	A1h	<read data>	2
Read TL	Reads stored value of low temperature limit from TL register.	A2h	<read data>	2
Write Config	Writes configuration data to configuration register.	0Ch	<write data>	2
Read Config	Reads configuration data from configuration register.	ACh	<read data>	2

NOTES:

1. In continuous conversion mode, a Stop Convert T command will halt continuous conversion. To restart, the Start Convert T command must be issued. In one-shot mode, a Start Convert T command must be issued for every temperature reading desired.
2. Writing to the E² requires up to 10 ms at room temperature. After issuing a write command no further writes should be requested for at least 10 ms.

FUNCTION EXAMPLE

Example: CPU sets up DS1620 for continuous conversion and thermostatic function.

CPU MODE	DS1620 MODE (3-WIRE)	DATA (LSB FIRST)	COMMENTS
TX	RX	0Ch	CPU issues Write Config command
TX	RX	00h	CPU sets DS1620 up for continuous conversion
TX	RX	Toggle $\overline{\text{RST}}$	CPU issues Reset to DS1620
TX	RX	01h	CPU issues Write TH command
TX	RX	0050h	CPU sends data for TH limit of +40°C
TX	RX	Toggle $\overline{\text{RST}}$	CPU issues Reset to DS1620
TX	RX	02h	CPU issues Write TL command
TX	RX	0014h	CPU sends data for TL limit of +10°C
TX	RX	Toggle $\overline{\text{RST}}$	CPU issues Reset to DS1620
TX	RX	A1h	CPU issues Read TH command
RX	TX	0050h	DS1620 sends back stored value of TH for CPU to verify
TX	RX	Toggle $\overline{\text{RST}}$	CPU issues Reset to DS1620
TX	RX	A2h	CPU issues Read TL command
RX	TX	0014h	DS1620 sends back stored value of TL for CPU to verify
TX	RX	Toggle $\overline{\text{RST}}$	CPU issues Reset to DS1620
TX	RX	EEh	CPU issues Start Convert T command
TX	RX	Drop $\overline{\text{RST}}$	CPU issues Reset to DS1620

READ DATA TRANSFER Figure 4

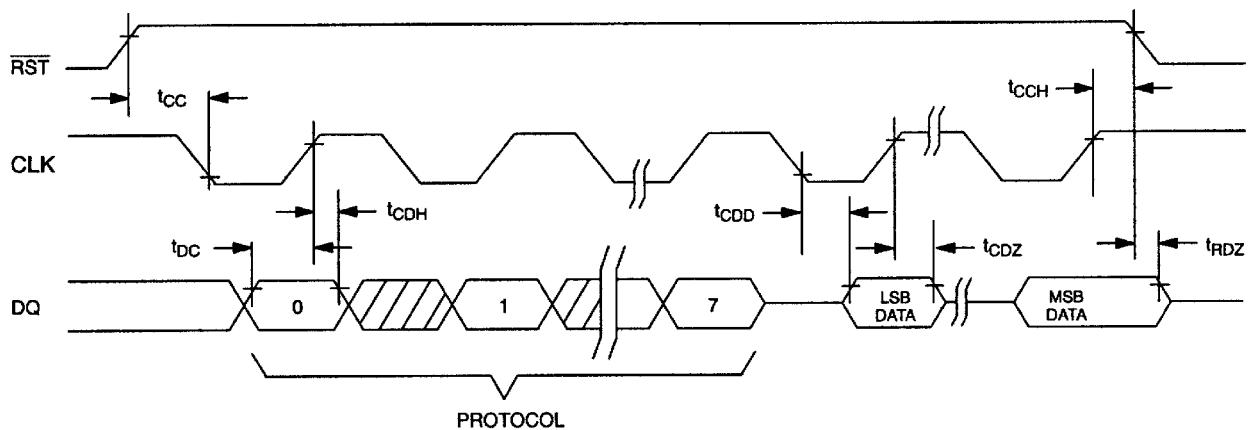

WRITE DATA TRANSFER Figure 5

NOTE: t_{CL} , t_{CH} , t_{R} , and t_{F} apply to both read and write data transfer.

ABSOLUTE MAXIMUM RATINGS*

Voltage on Any Pin Relative to Ground	-0.5V to +6.0V
Operating Temperature	-55°C to +125°C
Storage Temperature	-55°C to +125°C
Soldering Temperature	260°C for 10 seconds

* This is a stress rating only and functional operation of the device at these or any other conditions above those indicated in the operation sections of this specification is not implied. Exposure to absolute maximum rating conditions for extended periods of time may affect reliability.

RECOMMENDED DC OPERATING CONDITIONS

PARAMETER	SYMBOL	MIN	TYP	MAX	UNITS	NOTES
Supply	V_{DD}	2.7		5.5	V	1,2
Logic 1	V_{IH}	$0.7 \times V_{DD}$		$V_{CC} + 0.3$	V	1
Logic 0	V_{IL}	-0.3		$0.3 \times V_{DD}$	V	1

DC ELECTRICAL CHARACTERISTICS (-55°C to +125°C; $V_{DD}=2.7V$ to 5.5V)

PARAMETER	SYMBOL	CONDITION	MIN	MAX	UNITS	NOTES
Thermometer Error	T_{ERR}	0°C to +70°C $3.0V \leq V_{DD} \leq 5.5V$		±0.5	°C	2
		0°C to +70°C $2.7V \leq V_{DD} < 3.0V$		±1.25		
		-55°C to +125°C		±2.0		
Thermometer Resolution				12	Bits	
Logic 0 Output	V_{OL}			0.4	V	4
Logic 1 Output	V_{OH}		2.4		V	5
Input Resistance	R_I	\overline{RST} to GND	1		MΩ	
		DQ, CLK to V_{DD}	1		MΩ	
Active Supply Current	I_{CC}	0°C to +70°C		1	mA	6
Standby Supply Current	I_{STBY}	0°C to +70°C		1.5	μA	6
Input Current on Each Pin		$0.4 < V_{IO} < 0.9 \times V_{DD}$	-10	+10	μA	
Thermal Drift				±0.2	°C	7

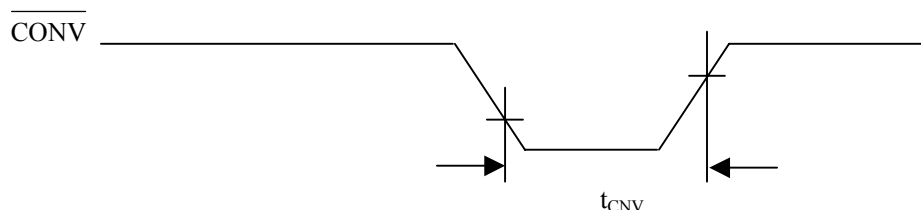
SINGLE CONVERT TIMING DIAGRAM (STAND-ALONE MODE)**AC ELECTRICAL CHARACTERISTICS** (-55°C to +125°C; $V_{DD}=2.7V$ to 5.5V)

PARAMETERS	SYMBOL	MIN	TYP	MAX	UNITS	NOTES
Temperature Conversion Time	T_{TC}			750	ms	
Data to CLK Setup	t_{DC}	35			ns	8
CLK to Data Hold	t_{CDH}	40			ns	8
CLK to Data Delay	t_{CDD}			150	ns	8, 9, 10
CLK Low Time	t_{CL}	285			ns	8
CLK High Time	t_{CH}	285			ns	8
CLK Frequency	f_{CLK}	DC		1.75	MHz	8
CLK Rise and Fall	t_R, t_F			500	ns	
\overline{RST} to CLK Setup	t_{CC}	100			ns	8
CLK to \overline{RST} Hold	t_{CCH}	40			ns	8
\overline{RST} Inactive Time	t_{CWH}	125			ns	8, 11
CLK High to I/O High-Z	t_{CDZ}			50	ns	8
\overline{RST} Low to I/O High-Z	t_{RDZ}			50	ns	8
Convert Pulse Width	t_{CNV}	250 ns		500 ms		12

AC ELECTRICAL CHARACTERISTICS (-55°C to +125°C; $V_{DD}=2.7V$ to 5.5V)

PARAMETER	SYMBOL	MIN	TYP	MAX	UNITS	NOTES
Input Capacitance	C_I		5		pF	
I/O Capacitance	$C_{I/O}$		10		pF	

EEPROM AC ELECTRICAL CHARACTERISTICS(-55°C to +125°C; $V_{DD}=2.7V$ to 5.5V)

PARAMETER	CONDITIONS	MIN	TYP	MAX	UNITS
EEPROM Write Cycle Time			4	10	Ms
EEPROM Writes	-55°C to +55°C	50k			Writes
EEPROM Data Retention	-55°C to +55°C	10			Years

NOTES:

- All voltages are referenced to ground.
- Valid for design revisions D1 and above. The supply range for Rev. C2 and below is $4.5V \leq 5.5V$.
- Thermometer error reflects temperature accuracy as tested during calibration.
- Logic 0 voltages are specified at a sink current of 4 mA
- Logic 1 voltages are specified at a source current of 1 mA.
- I_{STBY} , I_{CC} specified with \overline{DQ} , $\overline{CLK/CONV} = V_{DD}$, and $\overline{RST} = GND$.
- Drift data is based on a 1000hr stress test at +125°C with $V_{DD} = 5.5V$
- Measured at $V_{IH} = 0.7 \times V_{DD}$ or $V_{IL} = 0.3 \times V_{DD}$.
- Measured at $V_{OH} = 2.4V$ or $V_{OL} = 0.4V$.
- Load capacitance = 50 pF.
- t_{CWH} must be 10 ms minimum following any write command that involves the E² memory.
- 250ns is the guaranteed minimum pulse width for a conversion to start; however, a smaller pulse width may start a conversion.